

HG
GUNDAM THE ORIGIN
1/144 SCALE

機動戦士ガンダム
THE ORIGIN
MSD
MOBILE SUIT DISCOVERY



MS-06CK ZAKU HALF CANNON
PRINCIPALITY OF ZEON MASS-PRODUCED MOBILE SUIT
HG 1/144 ザク・ハーフキャノン
ZAKU HALF CANNON

180mmキャノン砲
180mm CANNON
ランドセル右側の兵装プラットフォームに装着された中距離支援用兵器。実体弾を射出する。
A mid-range support weapon attached to the armament platform on the right side of the back pack. It fires live rounds.

ビッグガン
BIG GUN
ランドセル下部にジョイントアームで装着された2連装ミサイル・ポッド。通常時はビッグガンを後方に回している。
A two-tube missile pod attached to the bottom of the back pack with a joint arm. It is normally turned toward the rear.

ランドセル BACK PACK
MS-06CKの武装はほぼランドセルに集約されている。各武装は全弾を撃ち尽くした後、コックピットからの操作で取り外すことができる。
The MS-06CK's armaments are almost entirely packed in the back pack. After using up all the weapons, they can be removed with a simple operation in the cockpit.

ガトリング・ガン
GATLING GUN
対空兵器で、ランドセル右側の兵装プラットフォームに取り付ける。給弾ベルトでランドセル内のボックスマガジンから装填される。
An anti-aircraft armament that is attached to the armament platform on the right side of the back pack. It is belt-fed from a magazine box stored inside the back pack.

ヒート・ホーク
HEAT HAWK
斧形の近接戦闘用武器。使用時は、赤熱化したブレードで、相手機の装甲を溶解する。腰に装着できる。
An axe-shaped weapon for close combat. It uses a super-heated blade to cut through the armor of the enemy. It can be attached to the waist.

<C-5型 TYPE C-5> <J型 TYPE J>
ザク・ハーフキャノンの本体はC-5型や陸戦型(J型)など複数のザクIIがベースとなっているため、機体によっては胸部など細部が異なっている。
The body of Zaku Half Cannon is based on a number of Zaku II models, including the C-5 and Ground Type (Type J), so details of the chest differ from unit to unit.

MARKINGS ①~⑭の番号はマーキングシールの番号です。□両腕または両脚とも同様に貼ります。●反対側も同様に貼ります。
① to ⑭ are the numbers of the marking stickers. □ Apply the stickers to both arms or legs in the same manner. ● Apply the stickers to the opposite side in the same manner.

※余ったマーキングシールはお好みで使用してください。* Please use remaining marking stickers as you like.
※マーキングシールの余白部分をカットして貼るとよりリアルになります。* Cut the blank space of the marking stickers for a more realistic appearance.

※よりリアルに仕上げたい方は、こちらの基本色をご覧ください。* For a more life-like finish, refer to the color guide.
※塗装には、より安全な「水性塗料」のご使用をおすすめします。* Use of water-based paint is recommended for safety reasons.
※カラー配合は参考値であり、画像とカラーガイドの色は異なる場合があります。* The color blending is shown for reference and the actual color may differ from the image.

COLOR GUIDE

<p>● 本体等ブラウン部 Body (Brown part): ホワイト(White) 60% ウッドブラウン(Wood brown) 30% +ブラック(Black) 10%</p>	<p>● 本体等ライトブラウン部 Body (Light brown part): ライトブラウン(Light brown) 60% +ホワイト(White) 40% +オレンジイエロー(Orange yellow) 少量(small dose)</p>	<p>● 本体等ダークブラウン部 Body (Dark brown part): マホガニー(Mahogany) 60% +カーキ(Khaki) 20% +ブラック(Black) 20%</p>	<p>● 武器等ライトグレー部 Weaponry (Light gray part): グレー(Gray) 50% +すみれ色(Violet) 35% +みず色(Light blue) 15%</p>
	<p>● フレーム等グレー部 Frame (Gray part): グレー(Gray) 90% +ブラック(Black) 10%</p>		<p>● センサーピンク部 Sensor (Pink part): ピンク(Pink) 100%</p>

MS-06CK ZAKU HALF CANNON ザク・ハーフキャノン

地球連邦軍が新型機動兵器の開発に成功した—その情報がジオン公国軍北米カリフォルニアベースに伝えられると、開発チームは来るべき対モビルスーツ戦に備えた試作機の開発に着手していた。MS-06K ザク・キャノンはMS-06をベースに中距離支援を主眼に製作された機体で、その試作は9機に留まったといわれる。しかし地球連邦軍の反撃が激しさを増していくと、ジオン公国地上軍では損耗した機体に応急処置を施して戦力の補強を行うようになっていた。MS-06CK ザク・ハーフキャノンはザクII C型にMS-06Kのランドセルを装備させたものである。ランドセルには180mmキャノン砲(もしくはガトリング・ガン)、2連装スモーク・ディスチャージャーを装備し、モビルスーツでの集団戦を想定したビッグガンも携行できた。

The Earth Federation Force succeeded in developing a new type of mobile suit—When this news reaches the North California Base of the Zeon Army, the development team launches a project to develop a prototype machine in anticipation of an imminent battle against the new mobile suit. The MS-06K Zaku Cannon was based on the MS-06, and was produced mainly to provide mid-range support. It is said that as many as 9 prototypes were produced. However, as the Earth Federation Force's counterattack intensifies, the ground forces of the Principality of Zeon are forced to apply emergency repair to its damaged machines to reinforce its military strength. The MS-06CK Zaku Half Cannon is the same mobile suit as the Zaku II type C with the addition of MS-06K's back pack. The back pack is equipped with a 180mm cannon (or gatling gun) and a twin smoke discharger, and can also carry a big gun for use in battles by groups of mobile suits.

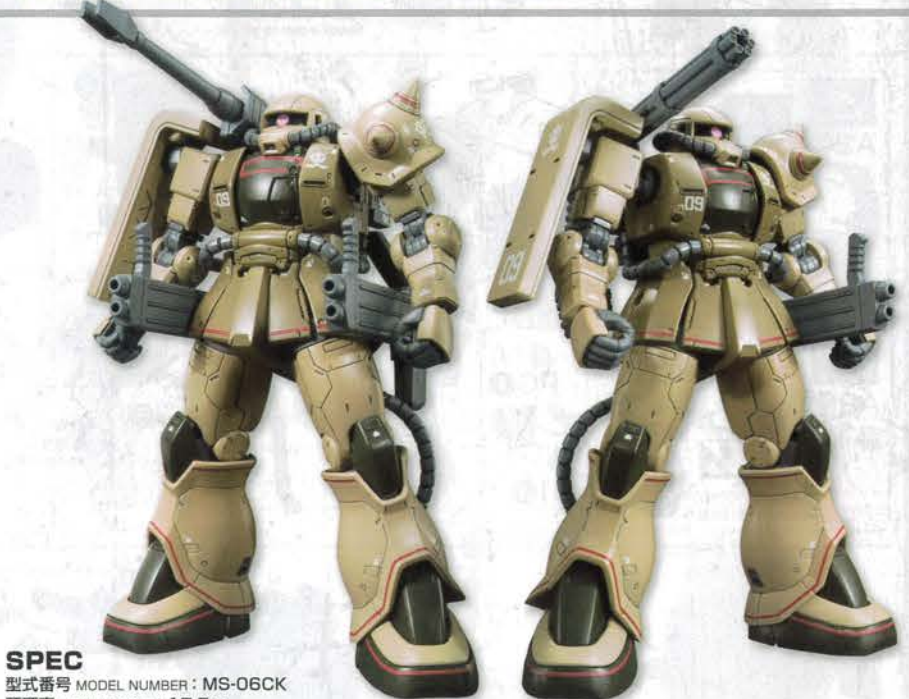

SPEC
型式番号 MODEL NUMBER: MS-06CK
頭頂高 HEAD HEIGHT: 17.5m
全幅 OVERALL WIDTH: 9.2m(スパイク含む: 9.7m including the spikes)
※データは劇中の設定です。
* The figures above are based on the models from the story.
※画像の完成品は塗装済みです。
* This completed product in the image has been painted.
※この商品は、「HG 1/144 ザク・ハーフキャノン」が1体のみ入っています。
* This package contains one set of "HG 1/144 ZAKU HALF CANNON" only.
※画像と商品とは多少異なりますのでご了承ください。
* The actual product may vary slightly from the images.

GUNDAM.INFO Search
www.gundam.info
バンダイホビーサイト ▶ www.bandai-hobby.net/
Any fees accrued by your access method and connection to the website are your own responsibility.
BANDAI 2017 MADE IN JAPAN



0219767

△ 警告 (けいこく)

保護者の方へ 必ずお読みください。

- 小部品があります。誤飲・窒息の危険がありますので、3才未満のお子様には絶対に与えないでください。

△ 注意 (ちゅうい)

- 縁部が鋭い箇所がありますので、注意してください。
- 先端が尖っている箇所がありますので、注意してください。
- 部品はきれいに切り取り、切り取ったあとのクズは捨ててください。
- 袋を頭からかぶったり、顔を覆ったりしないでください。窒息する恐れがあります。

△ WARNING

Parents and guardians, read the following instructions before use.

- CHOKING HAZARD - Small parts. Not for children under 3 years.

△ CAUTION

- Pay attention to sharp parts and edges.
- Pay attention to sharp parts. Be careful when handling.
- Cut the necessary parts from the sprue carefully, and discard the remnants.
- To avoid suffocation, do not put the plastic bag over your face.

《組み立てる時の注意》●組み立てる前に説明書をよく読みましょう。●部品は番号を確かめ、ニッパーなどできれいに切り取りましょう。●塗装にはより安全な「水性塗料」のご使用をおすすめします。●尖った先端や薄い縁端部に触れながらの組み立てには十分ご注意ください。※この商品に道具類は入っていませんので、別にご用意ください。

《Notes on assembly》●Carefully read the instructions before assembling. ●Check the part numbers, and cut them cleanly with nippers. ●Use of water-based paint is recommended for safety reasons. ●Pay extra attention when handling sharp points and edges. *Tools are not included.

PARTS LIST

※×印は使用しないパーツです。
× indicates parts not needed.

A1パーツ A1 Parts (PS)	A2パーツ A2 Parts (PS)	B1パーツ B1 Parts (PS)	D1パーツ D1 Parts (PS)	D2パーツ D2 Parts (PS)
E1パーツ E1 Parts (PS)	Fパーツ F Parts (PS)	Iパーツ I Parts (PS)	Jパーツ J Parts (PS)	PC-001 (PE)

シール Stickers

※部品の向きや左右など、イラストをよく見て組み立ててください。
*Refer to the illustrations and pay attention to parts orientation/direction during assembly.

※形状が似ているパーツがありますので番号を確認し、順番に組み立ててください。
*Some parts may be difficult to distinguish from one another. Check the part numbers and follow the assembly order.

組み立て中に使用されているアイコン
Symbols used in instructions

① シールの番号 Sticker number
 後から組み立てる Assemble this part later.
 切り取り注意 Do not cut.
 ①→②の順番で組み立てる Assemble in numerical order ①→②...
 切り取ります Cut here.

各部品はニッパーなどで、きれいに切り取りましょう。
Use modeling nippers to trim the excess sprue from each part.

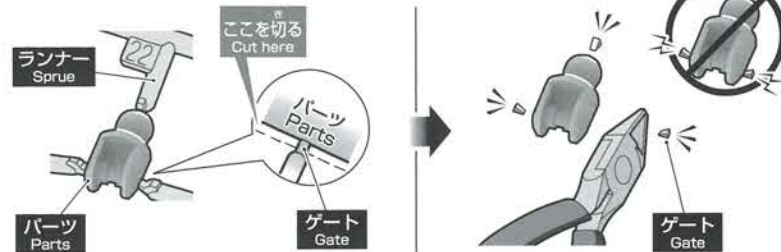

PC部品は軟質素材のため、つぶさないようにしっかり取り付けましょう。
PC (polycap) parts are made of a soft material. Take care not to crush them during assembly.

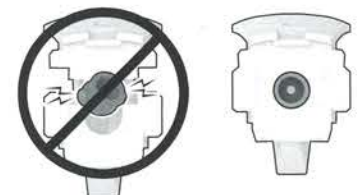

BODY

※C-5型とJ型のどちらかを選んで組み立てます。
*Choose either Type C-5 or Type J to assemble.

TYPE J D122, D123, D118, D119, D120
C-5型 A226, A233, A234, A225, A224, A223, A222, A221, A220, A219, A218, A217, A216, A215, A214, A213, A212, A211, A210, A209, A208, A207, A206, A205, A204, A203, A202, A201, A200, A199, A198, A197, A196, A195, A194, A193, A192, A191, A190, A189, A188, A187, A186, A185, A184, A183, A182, A181, A180, A179, A178, A177, A176, A175, A174, A173, A172, A171, A170, A169, A168, A167, A166, A165, A164, A163, A162, A161, A160, A159, A158, A157, A156, A155, A154, A153, A152, A151, A150, A149, A148, A147, A146, A145, A144, A143, A142, A141, A140, A139, A138, A137, A136, A135, A134, A133, A132, A131, A130, A129, A128, A127, A126, A125, A124, A123, A122, A121, A120, A119, A118, A117, A116, A115, A114, A113, A112, A111, A110, A109, A108, A107, A106, A105, A104, A103, A102, A101, A100, A99, A98, A97, A96, A95, A94, A93, A92, A91, A90, A89, A88, A87, A86, A85, A84, A83, A82, A81, A80, A79, A78, A77, A76, A75, A74, A73, A72, A71, A70, A69, A68, A67, A66, A65, A64, A63, A62, A61, A60, A59, A58, A57, A56, A55, A54, A53, A52, A51, A50, A49, A48, A47, A46, A45, A44, A43, A42, A41, A40, A39, A38, A37, A36, A35, A34, A33, A32, A31, A30, A29, A28, A27, A26, A25, A24, A23, A22, A21, A20, A19, A18, A17, A16, A15, A14, A13, A12, A11, A10, A9, A8, A7, A6, A5, A4, A3, A2, A1, A0

TYPE J B16, B17, B18, B19, B20, B21, B22, B23, B24, B25, B26, B27, B28, B29, B30, B31, B32, B33, B34, B35, B36, B37, B38, B39, B40, B41, B42, B43, B44, B45, B46, B47, B48, B49, B50, B51, B52, B53, B54, B55, B56, B57, B58, B59, B60, B61, B62, B63, B64, B65, B66, B67, B68, B69, B70, B71, B72, B73, B74, B75, B76, B77, B78, B79, B80, B81, B82, B83, B84, B85, B86, B87, B88, B89, B90, B91, B92, B93, B94, B95, B96, B97, B98, B99, B100

C-5型 PC8, PC10, PC11, PC12, PC13, PC14, PC15, PC16, PC17, PC18, PC19, PC20, PC21, PC22, PC23, PC24, PC25, PC26, PC27, PC28, PC29, PC30, PC31, PC32, PC33, PC34, PC35, PC36, PC37, PC38, PC39, PC40, PC41, PC42, PC43, PC44, PC45, PC46, PC47, PC48, PC49, PC50, PC51, PC52, PC53, PC54, PC55, PC56, PC57, PC58, PC59, PC60, PC61, PC62, PC63, PC64, PC65, PC66, PC67, PC68, PC69, PC70, PC71, PC72, PC73, PC74, PC75, PC76, PC77, PC78, PC79, PC80, PC81, PC82, PC83, PC84, PC85, PC86, PC87, PC88, PC89, PC90, PC91, PC92, PC93, PC94, PC95, PC96, PC97, PC98, PC99, PC100

TYPE J J4, J3, J2, J1, J0
C-5型 J4, J3, J2, J1, J0

TYPE J I8, I7, I6, I5, I4, I3, I2, I1, I0
C-5型 I8, I7, I6, I5, I4, I3, I2, I1, I0

TYPE J F10, F9, F8, F7, F6, F5, F4, F3, F2, F1, F0
C-5型 F10, F9, F8, F7, F6, F5, F4, F3, F2, F1, F0

TYPE J A227, A228, A229, A230, A231, A232, A235, A236, A237, A238, A239, A240, A241, A242, A243, A244, A245, A246, A247, A248, A249, A250, A251, A252, A253, A254, A255, A256, A257, A258, A259, A260, A261, A262, A263, A264, A265, A266, A267, A268, A269, A270, A271, A272, A273, A274, A275, A276, A277, A278, A279, A280, A281, A282, A283, A284, A285, A286, A287, A288, A289, A290, A291, A292, A293, A294, A295, A296, A297, A298, A299, A300

TYPE J A23, A24, A25, A26, A27, A28, A29, A30, A31, A32, A33, A34, A35, A36, A37, A38, A39, A40, A41, A42, A43, A44, A45, A46, A47, A48, A49, A50, A51, A52, A53, A54, A55, A56, A57, A58, A59, A60, A61, A62, A63, A64, A65, A66, A67, A68, A69, A70, A71, A72, A73, A74, A75, A76, A77, A78, A79, A80, A81, A82, A83, A84, A85, A86, A87, A88, A89, A90, A91, A92, A93, A94, A95, A96, A97, A98, A99, A100

C-5型 A23, A24, A25, A26, A27, A28, A29, A30, A31, A32, A33, A34, A35, A36, A37, A38, A39, A40, A41, A42, A43, A44, A45, A46, A47, A48, A49, A50, A51, A52, A53, A54, A55, A56, A57, A58, A59, A60, A61, A62, A63, A64, A65, A66, A67, A68, A69, A70, A71, A72, A73, A74, A75, A76, A77, A78, A79, A80, A81, A82, A83, A84, A85, A86, A87, A88, A89, A90, A91, A92, A93, A94, A95, A96, A97, A98, A99, A100

TYPE J A27, A28, A29, A30, A31, A32, A33, A34, A35, A36, A37, A38, A39, A40, A41, A42, A43, A44, A45, A46, A47, A48, A49, A50, A51, A52, A53, A54, A55, A56, A57, A58, A59, A60, A61, A62, A63, A64, A65, A66, A67, A68, A69, A70, A71, A72, A73, A74, A75, A76, A77, A78, A79, A80, A81, A82, A83, A84, A85, A86, A87, A88, A89, A90, A91, A92, A93, A94, A95, A96, A97, A98, A99, A100

C-5型 A27, A28, A29, A30, A31, A32, A33, A34, A35, A36, A37, A38, A39, A40, A41, A42, A43, A44, A45, A46, A47, A48, A49, A50, A51, A52, A53, A54, A55, A56, A57, A58, A59, A60, A61, A62, A63, A64, A65, A66, A67, A68, A69, A70, A71, A72, A73, A74, A75, A76, A77, A78, A79, A80, A81, A82, A83, A84, A85, A86, A87, A88, A89, A90, A91, A92, A93, A94, A95, A96, A97, A98, A99, A100

HEAD

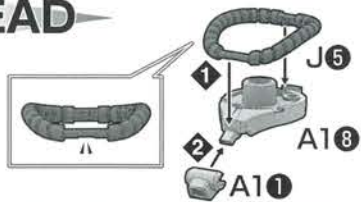

FEET

×2 (2個作る) Build two sets.

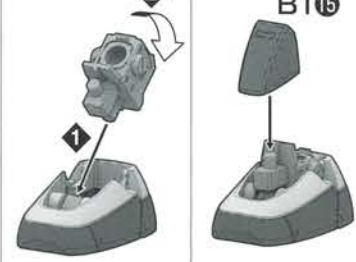
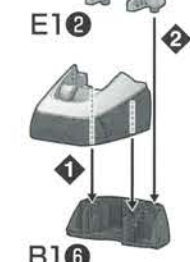
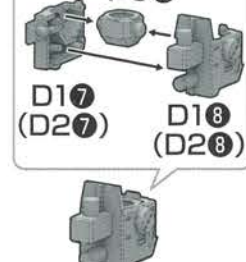
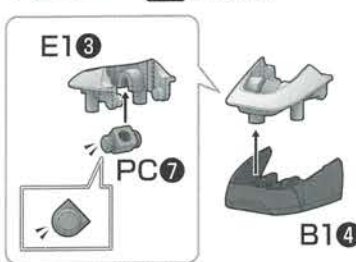

WAIST

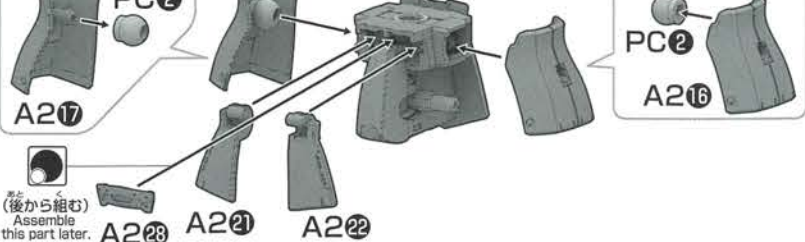
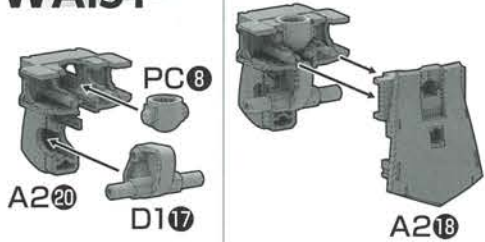

LEFT ARM

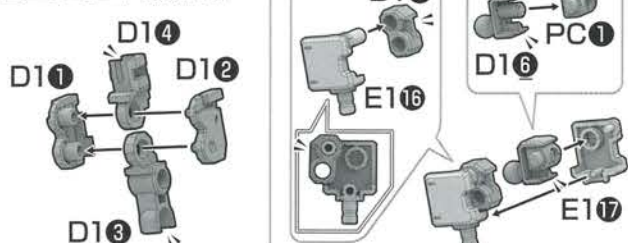

RIGHT ARM

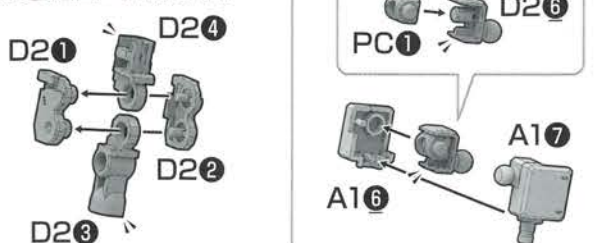

LEFT LEG

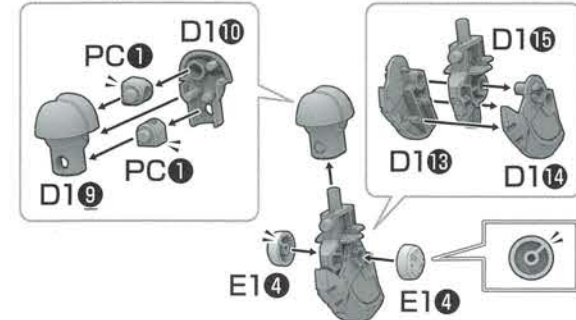

RIGHT LEG

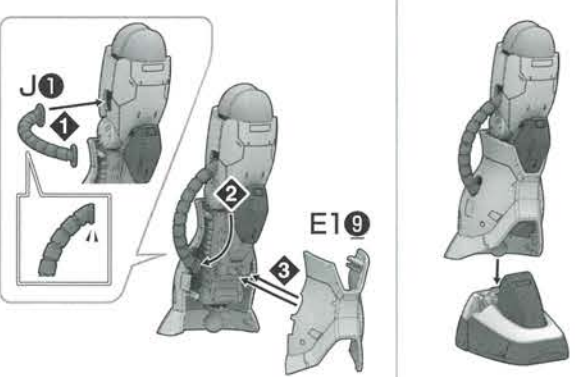
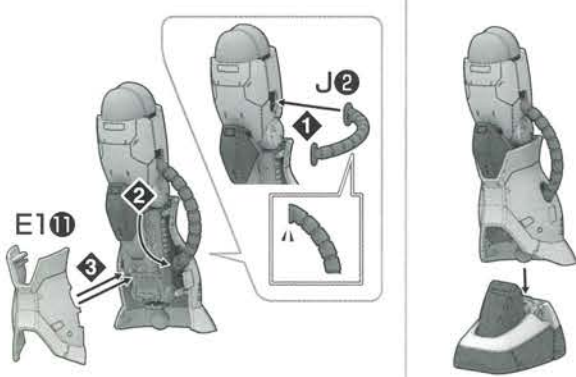
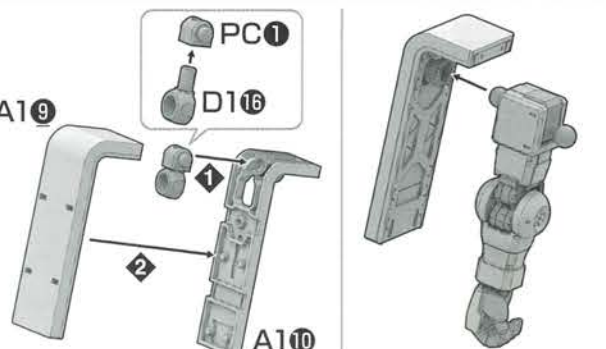
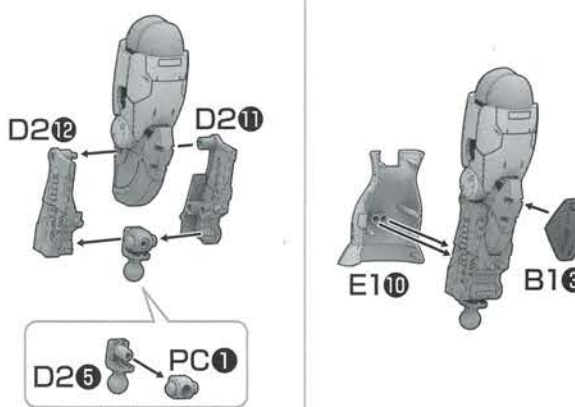
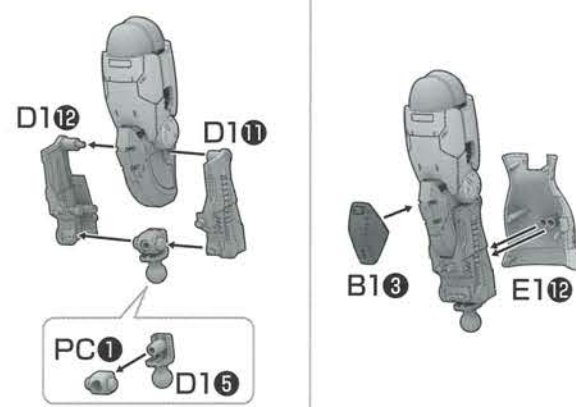
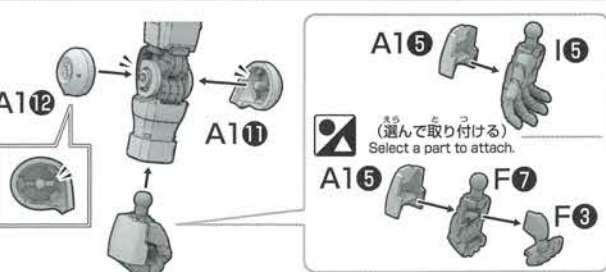
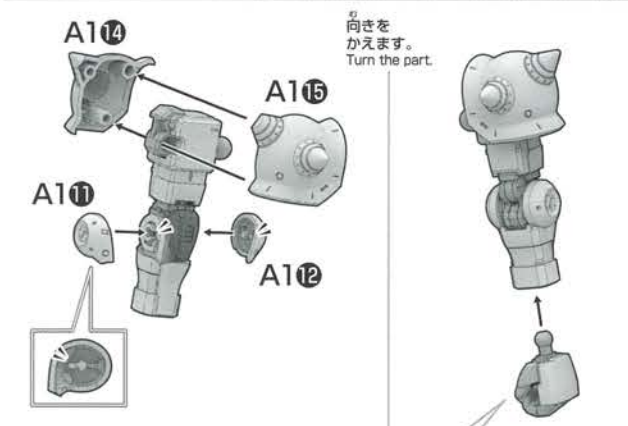
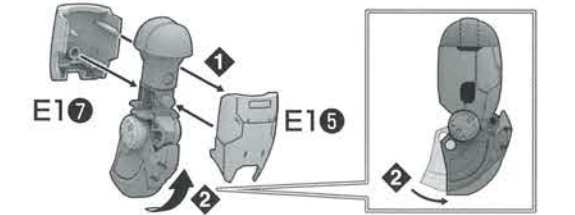
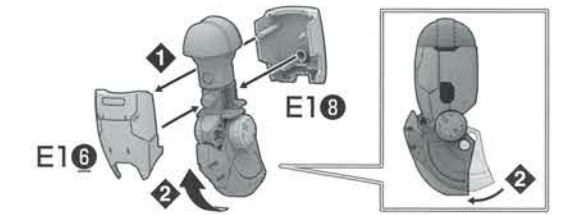
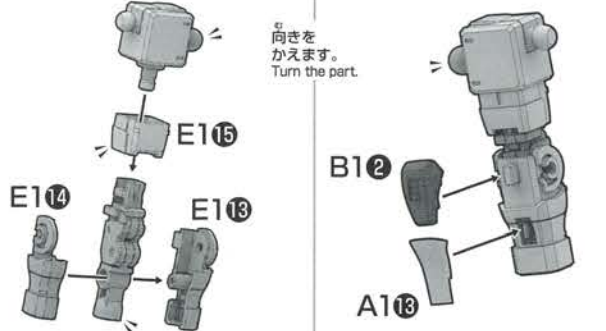
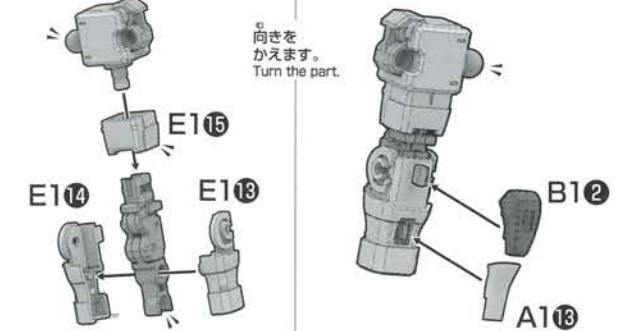
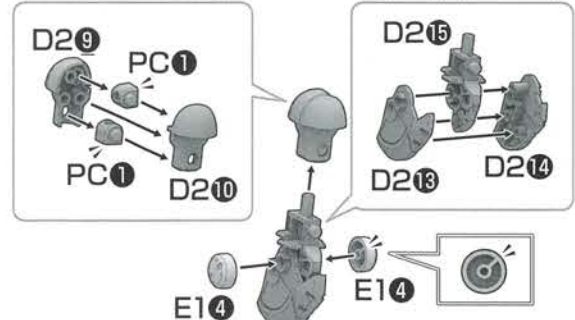

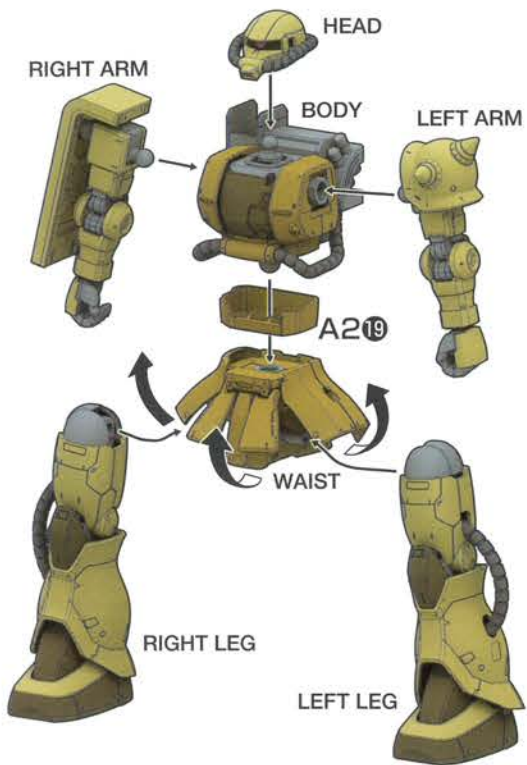

ガトリング・ガン
GATLING GUN

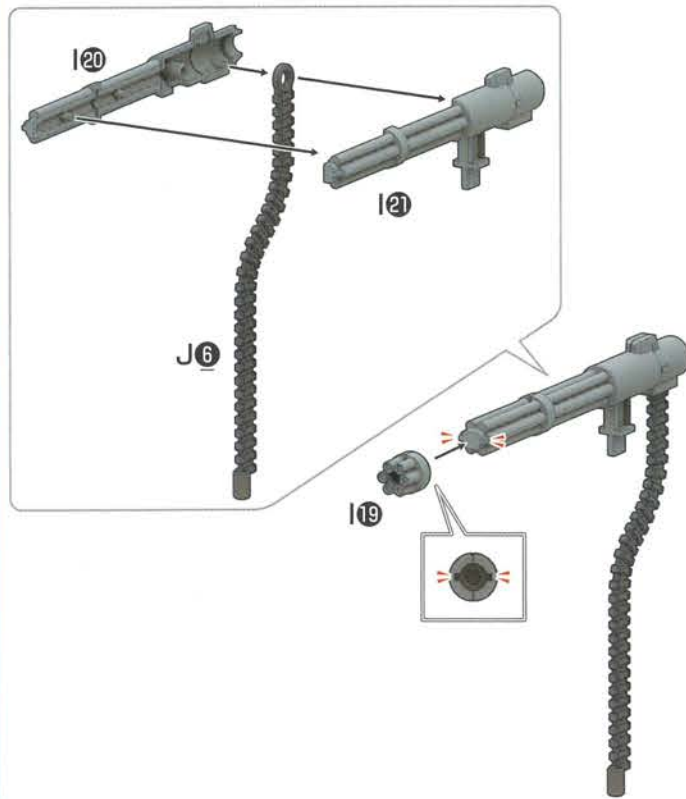

ガトリング・ガン+ビッグガン
GATLING GUN with BIG GUN

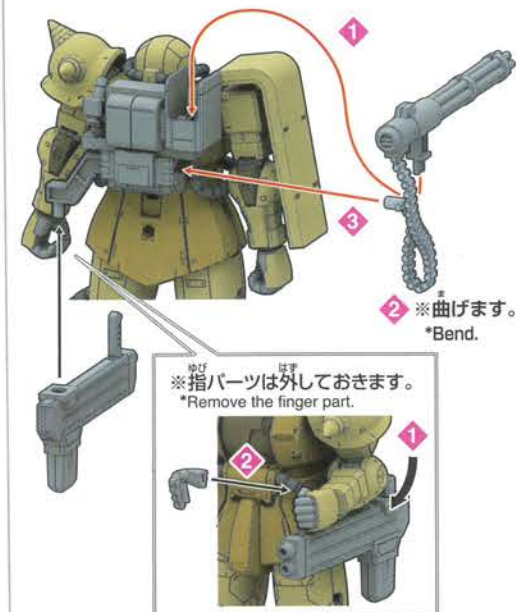
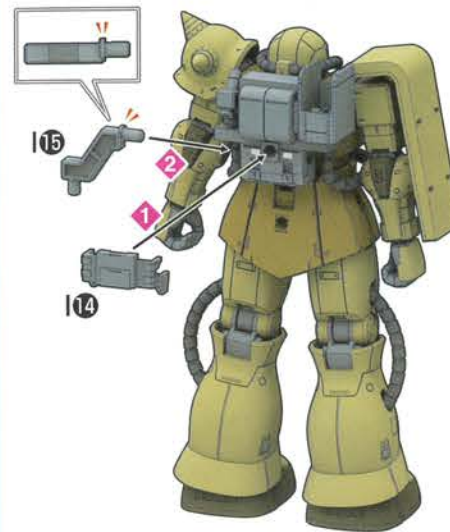

(選んで取り付ける)
Select a part to attach.

180mm キャノン砲+ビッグガン
180mm CANNON with BIG GUN

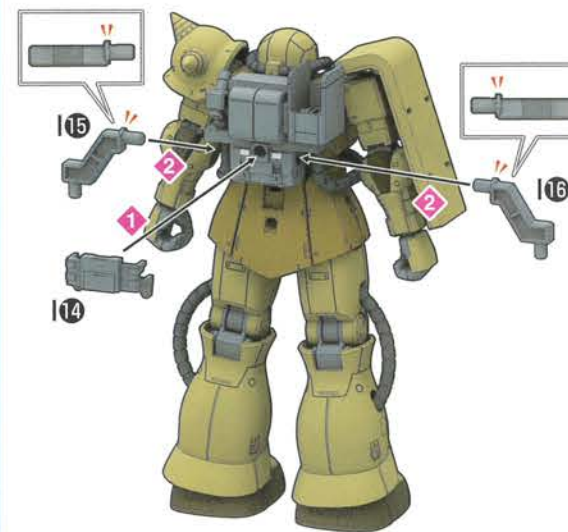

ヒート・ホーク
HEAT HAWK

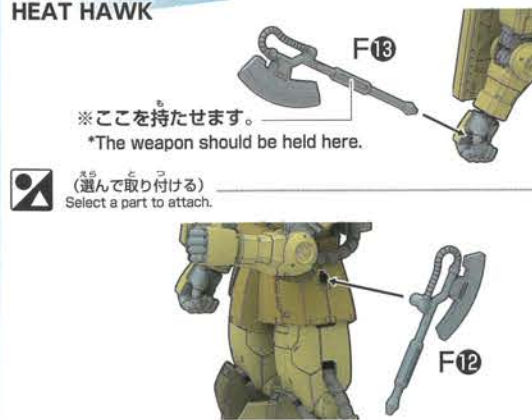

180mm キャノン砲
180mm CANNON

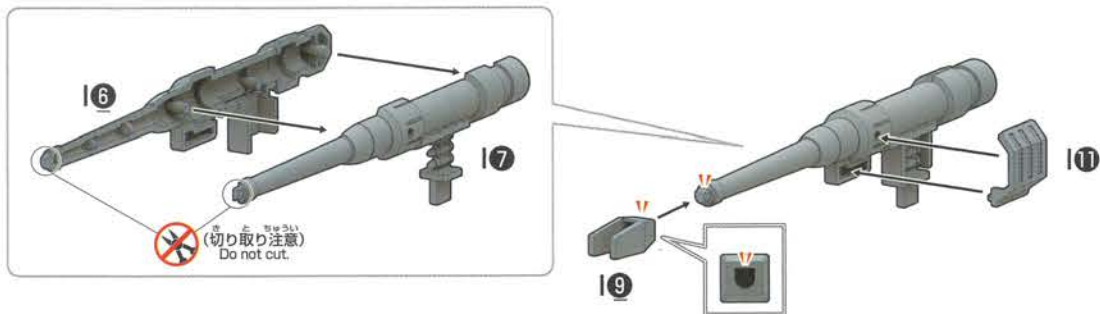

ビッグガン
BIG GUN

×2 (2個作る)
Build two sets.

